

OPERATING INSTRUCTIONS

10.2" Portable LCD Television *PLC10V49*



AIR (TV)/CABLE MODE SELECTION

The AIR/CABLE menu option is set at the factory to "AIR" to allow reception of over-the-air TV broadcast using the included antenna. If you wish to tune cable television channels, this option must be set to "CABLE". Please refer to page 15 of this owner's manual for the details of this menu.

TV RECEPTION

1. Reception of over-the-air TV broadcast varies with location. Lack of reception of certain stations or interruptions in playback does not indicate a problem with your product but rather a weak received signal. Try repositioning the antenna, moving the unit to another location with better signal or connecting to your cable, satellite or home antenna. If you have recently relocated the TV, please re-scan channels.
2. TV broadcast is not intended to be received in a moving vehicle. For best reception, be sure to use this TV only in a stationary setting.



Safety Precautions

- Power Supply 1
- Installation 2
- Use and Maintenance 3
- Important Safety Instructions 4-5

User Guidance Information

- Accessories 6
- Names of each part 6-7
- Remote Control 8

Connection

- Power connection 9
- Antenna connection 9
- Input connections 10
- Headphone connection 10

Basic Use

- Powering the LCD TV 11
- Selecting input source 11

Application

- Operating the menu 12
- Customizing the PICTURE Settings 13
- Customizing the FUNCTION Settings 14
- Customizing the TUNING Settings 15
- EPG menu 16
- Closed Caption 16

Media Operation

- Playing media files from the USB and SD card slots 17-18
- System Settings for Media 19-20

Maintenance and Service

- Troubleshooting 21

Safety Precautions

Power Supply

Warnings

Do not touch the power plug with wet hands.

- Doing so may result in electric shock.

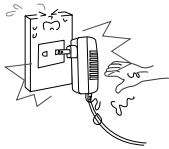

Do not use a damaged power cord or plug or a loose outlet.

- Doing so may result in fire or electric shock.

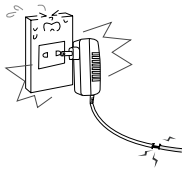

Do not plug several devices into the same outlet.

- Doing so may cause the outlet to overheat and start a fire.

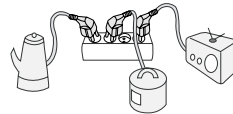

Insert the power plug fully into the outlet.

- A loose or improperly inserted power plug may result in fire.

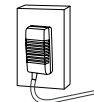

Do not bend the power cord excessively or place heavy objects on it.

- Doing so may result in fire or electric shock.



Be sure to ground the unit.

- Failing to do so may lead to electric shock when a short circuit or overload occurs. If necessary, install a ground fault circuit breaker. Never ground to a telephone line, lighting rod, or metal gas pipe. (Doing so may result in fire, electric shock, or other hazards.)

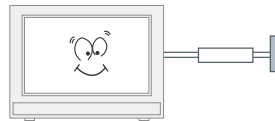

Cautions

When disconnecting the power cord from an AC outlet, always grasp it by the plug.

- Pulling on the cord can damage the internal wire and may result in fire.

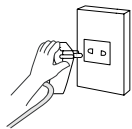

Always unplug the unit before cleaning.

- Not doing so may result in fire or electric shock.

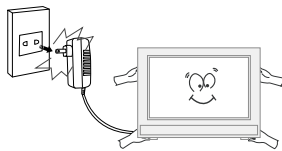

The purpose of these precautions is to ensure user safety and prevent property damage.

Be sure to read and observe all safety precautions.



Installation

Warnings

Do not place the unit where it is exposed to rain, excessive moisture or grease.

- Doing so may result in fire electric shock, malfunction, or deformation.

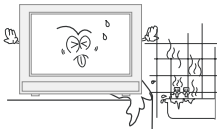

Do not use or store flammable or combustible materials near the unit.

- Doing so may result in fire or explosion.



Do not place a burning candle, burning anti-mosquito incense, or lighted cigarette on top of the unit. Do not place the unit near any heat source such as a fireplace or space heater.

- Doing so poses a serious risk of fire.



Do not run power cords near heat-producing appliances such as radiators, stoves, or irons.

- The excessive heat could melt the insulation and expose live wires, resulting in fire or electric shock.



Install the antenna away from high-voltage power lines and communication cables and make sure it is installed securely.

- If the antenna touches a power line, contact with the antenna could result in fire, electric shock, serious injury, or death.

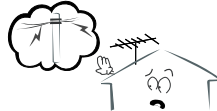

Cautions

Do not cover the unit with a tablecloth, curtain, or other material.

- If the temperature inside the unit rises, it may result in fire.



Warning

Form a drip loop where the coaxial antenna cable enters your building to prevent rainwater from traveling along the cable and coming in contact with the antenna input terminal.

- If rainwater finds its way inside the unit, it may result in fire or electric shock.



- The following precautions are divided into "Warning" and "Caution".
- Warning: Ignoring this precaution may result in death or serious injury.
- Caution: Ignoring this precaution may result in injury or property damage.

Use and Maintenance

Warnings

Disconnect the power cord from the wall outlet during an electric storm.

- . Not doing so may result in fire or electric shock.

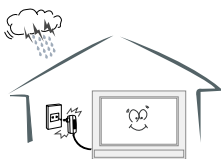

Do not insert any metal objects, such as a screwdriver, paper clip, or A/V terminals..

- . Doing so poses a serious risk of fire or electric shock.

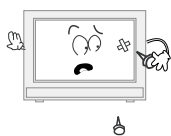

Never disassemble or modify the unit in any way. Do not attempt to service the unit yourself.

- . Doing so may result in fire or electric shock. If the unit requires repair, contact the service center.



Cautions

When not using the unit for long periods of time, disconnect the power cord from the wall outlet.

- . Dust could accumulate over time on the unit and cause it to generate heat and ignite, or deteriorate insulation, which in turn may result in an electrical fire.

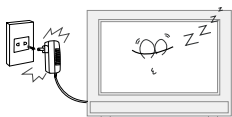

When moving the unit, be sure to turn off unit and unplug the power cord from the wall outlet.

- . Moving the unit with the power cord connected to the outlet may cause damage to the cord, resulting in fire or electric shock.



If you notice any unusual odors or smoke around the unit, immediately disconnect the unit from the outlet and contact the service center.

- . Failure to do so may result in fire or electric shock.

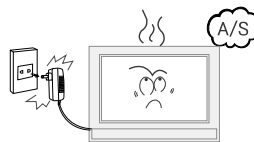

Warning

When removing the batteries from the remote control, make sure children do not swallow them. Keep the batteries out of the reach of infants and children.

- . If a child has swallow a battery, seek medical attention immediately.



Wipe off any moisture, dirt, or dust on the power plug pins with a clean dry cloth.

- . Failure to do so may result in fire or electric shock.

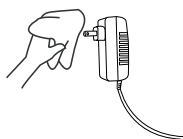

Always turn off the unit and unplug the power cord when cleaning the unit. Use a soft dry cloth to clean the unit.

- . Never clean with industrial strength polish, wax, benzene paint thinner, air freshener, lubricant, detergent, or other such chemicals. Also, do not clean with a damp cloth.

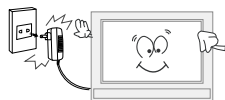

As a disconnect device from the MAINS, the MAINS plug of the attached adapter shall remain readily operable.

Important Safety Instructions

Warnings and Precautions





To prevent any injuries, the following safety precautions should be observed in the installation, use, servicing and maintenance of this equipment.

Before operating this equipment, please read this manual completely, and keep it nearby for future reference.

- 1) Read these instructions.
- 2) Keep these instructions.
- 3) Heed all warnings.
- 4) Follow all instructions.
- 5) Do not use this apparatus near water.
- 6) Clean only with a dry cloth.
- 7) Do not block any of the ventilation openings. Install in accordance with the manufacturer's instructions.
- 8) Do not install near any heat sources such as radiators, heat registers, stoves, or other apparatus (including amplifiers) that produce heat.
- 9) Do not defeat the safety purpose of the polarized or grounding type plug. A polarized plug has two blades with one wider than the other. A grounding type plug has two blades and a third grounding prong. The wide blade or the third prong is provided for your safety. When the provided plug does not fit into your outlet, consult an electrician for replacement of the obsolete outlet.
- 10) Protect the power cord from being walked on or pinched particularly at plugs, convenience receptacles, and the point where they exit from the apparatus.
- 11) Only use the attachments/accessories specified by the manufacturer.
- 12) Use only with a cart, stand, tripod, bracket, or table specified by the manufacturer, or sold with the apparatus. When a cart is used, use caution when moving the cart/apparatus.
- 13) Unplug this apparatus during lightning storms or when unused for long periods of time.
- 14) Servicing is required when the apparatus has been damaged in any way, such as power supply cord or plug is damaged, liquid has been spilled or objects have fallen into the apparatus, the apparatus has been exposed to rain or moisture, the apparatus does not operate normally, or the apparatus has been dropped.

Important Safety Instructions

- Servicing is required when the apparatus has been damaged in any way. Your TV could require servicing if any of the following occur:
 - Supply cord or plug is damaged
 - Objects have fallen into the apparatus
 - Apparatus has been exposed to rain or moisture
 - Apparatus has been dropped
 - Apparatus does not operate normally

   <p>CAUTION: TO REDUCE THE RISK OF ELECTRIC SHOCK, DO NOT REMOVE COVER (OR BACK), NO USER-SERVICEABLE PARTS INSIDE. REFER SERVICING TO QUALIFIED SERVICE PERSONNEL.</p>	 <p>The lightning flash with an arrowhead symbol, within an equilateral triangle is intended to alert the user to the presence of uninsulated "dangerous voltage" within the product's enclosure that may be of sufficient magnitude to constitute a risk of electric shock to persons.</p>
	 <p>The exclamation point within an equilateral triangle is intended to alert the user to the presence of important operating and maintenance (servicing) instructions in the literature accompanying the appliance.</p>

5B-En

Apparatus with Class I construction shall be connected to a Main socket outlet with a protective earthing connection.

WARNING

TO PREVENT DAMAGE WHICH MAY RESULT IN FIRE OR ELECTRIC SHOCK HAZARD, DO NOT EXPOSE THIS APPLIANCE TO RAIN OR MOISTURE.

Caution :

- These servicing instructions are for use by qualified service personnel only. To reduce the risk of electric shock, do not perform any servicing other than that contained in the operating instructions unless you are qualified to do so.
- Any changes or modifications not expressly approved by the party responsible for compliance could void the user's authority to operate the equipment.



3124140
CONFORMS TO UL STD. 60065

This unit complies with America Safety directives.



This unit complies with FCC directives.

Accessories

- The following accessories are included in the package

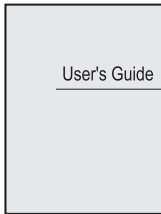

User's Guide



Remote Control



Power adapter



TV antenna



AV connection cable



Headphones



Car adapter

Names of each part

Front view

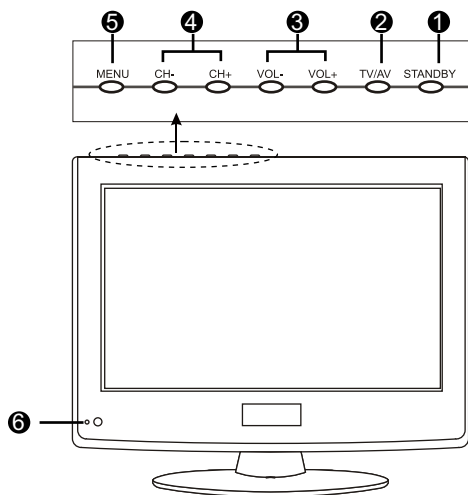

- ① STANDBY —Switch the power on/standby.
- ② TV/AV —Input source select.
- ③ VOL+/- —Volume up/down.
- ④ CH+/- —Channel Program up/down.
- ⑤ MENU —Press to display the OSD menu.
- ⑥ LED indicator and remote control window.
LED Blue – Power ON, LED Red – Standby

Profile view

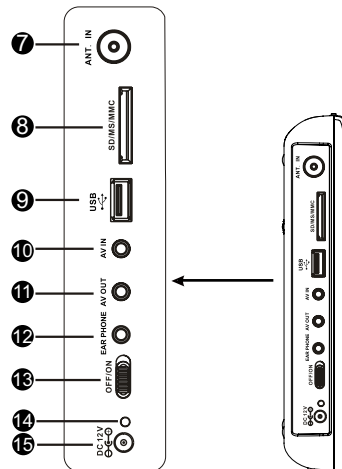

- ⑦ ANT.IN —Connect to antenna.
- ⑧ SD/MS/MMC card reader
- ⑨ USB jack
- ⑩ AV IN —Video & Audio input.
- ⑪ AV OUT —Video & Audio output.
- ⑫ EAR PHONE— Headphone out.
- ⑬ ON/OFF —Power switch:
up--power on, down--power off.
- ⑭ Power led indicator:
Light red—Battery is not full.
- ⑮ DC IN —Connect to DC power supply.

Names of each part

Disassembly of TV Base

- Contrarotate the base bolt to release the base of the TV.

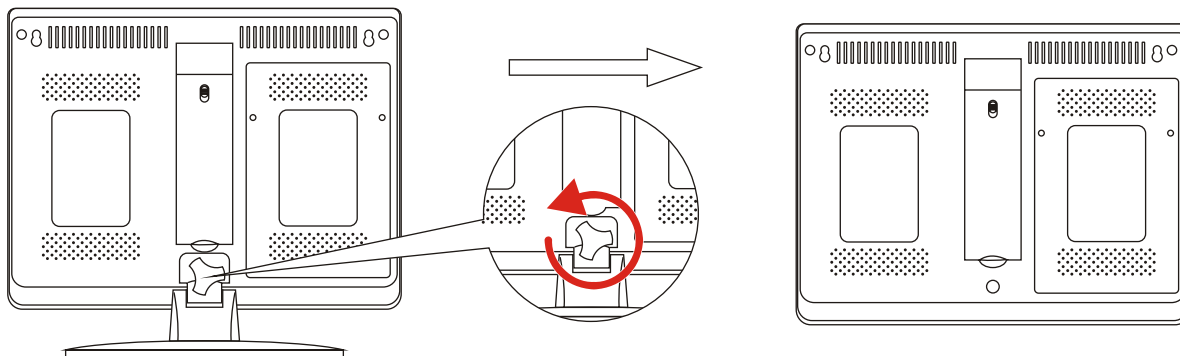

Wall-Hanging

- Hang the TV on the wall with the slots on the TV back.

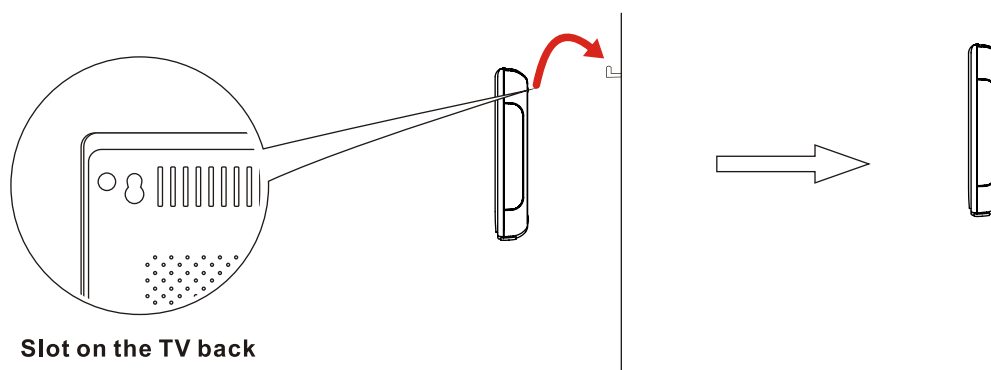

Standing the TV with Bracket

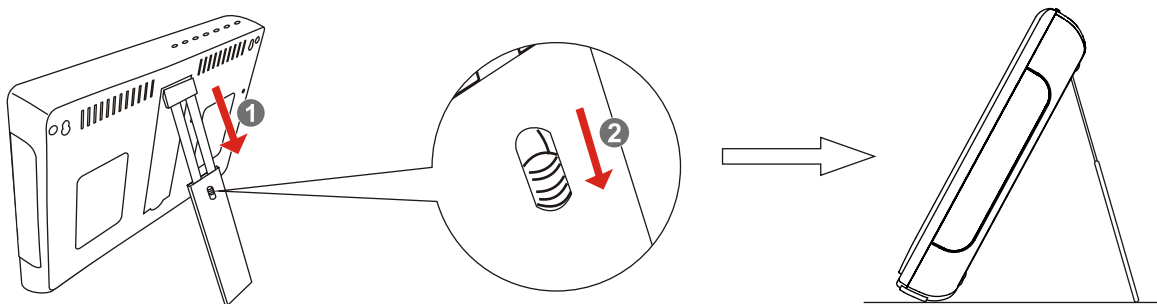

1 Pull the bracket out.

2 Pull the switch down to lock the bracket.

Remote Control

● Function of remote control buttons

The remote control uses infra-Red(IR). Point it towards the front of the LCD TV. The remote control may not work correctly if it is operated out of range or out of angle.



STANDBY : Press to turn the TV on/standby.
TV/AV : Press to display the input source menu.
MUTE : Press to mute the TV, press again or press **VOL+/-** button to unmute.
DISPLAY : Press to display the current program information.

NUMBER buttons and -/-- button:

Choose channel directly.
 Press -/-- buttons to select “-”, and press a number button to select the channel;
 Press -/-- buttons to select “- -”, and press two number buttons to select the channel;
 Press -/-- buttons to select “- - -”, and press three number buttons to select the channel;

:Return to the previous channel viewed.

LANG : Press to display the language select menu.
CC : Closed caption(see page 16).
EPG : To show the Electronic Program Guide during no-menu state only(see page 16).
ZOOM : Press to change the screen display mode.

VOL+/- : Volume up/down.

SLEEP : Timer.

LCD-MENU : Press to display OSD menu.

THUMBSTICK (▲/▼/◀/▶) : Allows you to navigate the on-screen menus and adjust the system settings to your preference.

ENTER : Confirm for source menu.

CH+/- : Channel/program up/down.

Buttons for Media operation

SUB : Press to turn on/off the subtitle display.

▶|| : Play/pause. ■ : Stop

SLOW : Slow the playing speed.

SETUP : Press to display the SETUP menu.

◀▶ : Fast reverse/forward.

◀◀ ▶▶ : Previous chapter/next chapter.

PROG : Edit the program and play.

A-B : Select and play the preferable paragraph of program by pressing this key twice at the beginning and end of it.

REPEAT : Repeat playing the title or chapter.

GOTO : Play your favorite title/chapter/track.

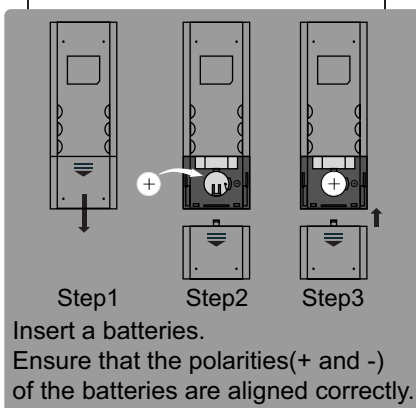

How to use the remote control

- Check the polarity(+,-) of the batteries in the remote control.
- Check that the batteries have power.
- Check that the LCD TV is powered and that it is properly plugged in.
- Check if any three-wavelength lamp, special fluorescent or neon sign is turned on near the LCD TV.
- The remote control should be operated within 30 feet (7m) and 30° to the left and the right of the IR receiver at the front of the LCD TV.
- Used batteries should be disposed properly.

Power connection

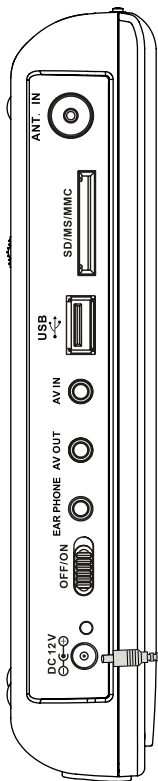

Power Connecting

1. Connect the small round plug on the power adapter cable to the power input socket at the rear of the set.
2. Connect the power adapter to the main supply.

Note:

This model has a built-in rechargeable Li-ion battery. You can enjoy watching TV for approximately 2 hours using battery power after a full charge. You can charge the battery by connecting the supplied AC adapter. It will take about 3 hours to charge fully.

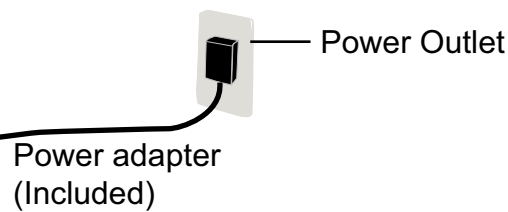

Antenna connection

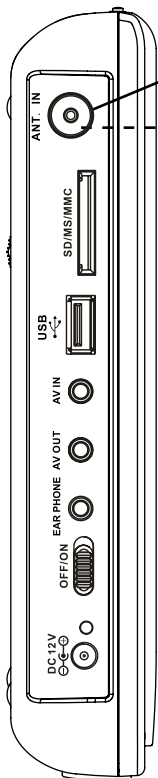

Analog+Digital 75 Ω

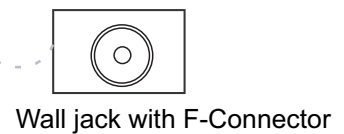
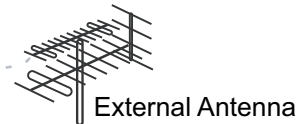
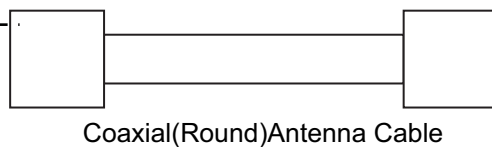

Input Connections

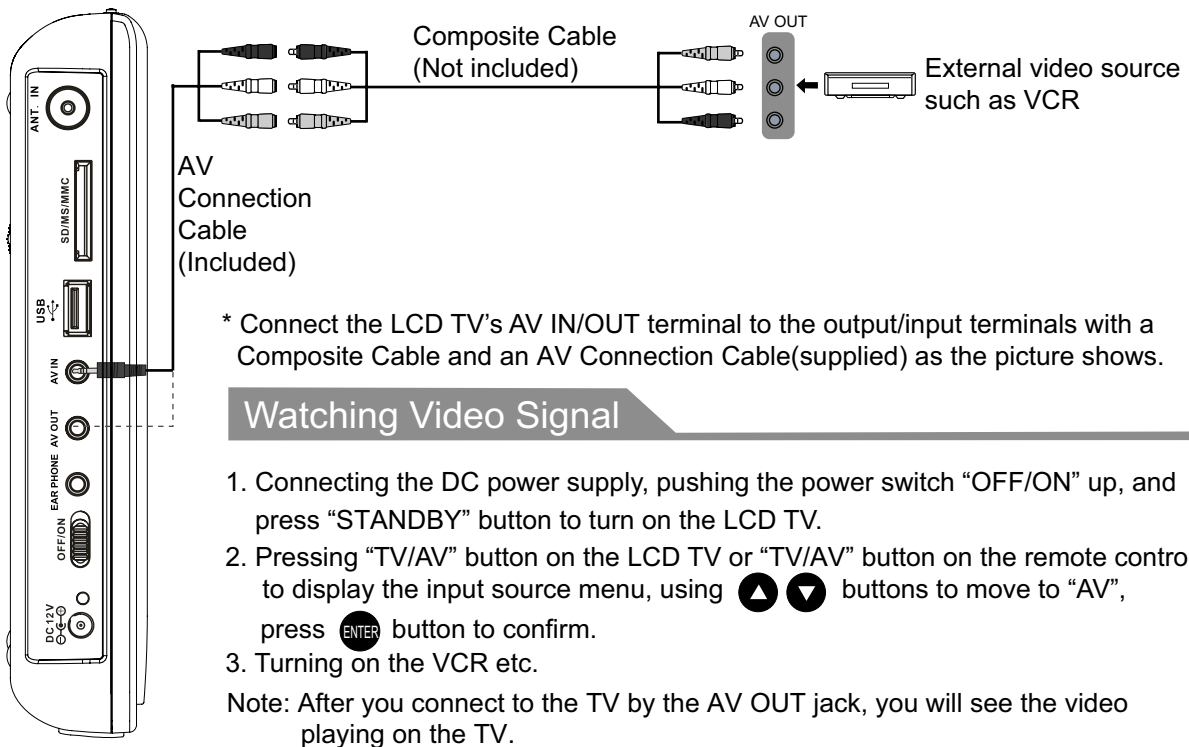

Headphone Connection

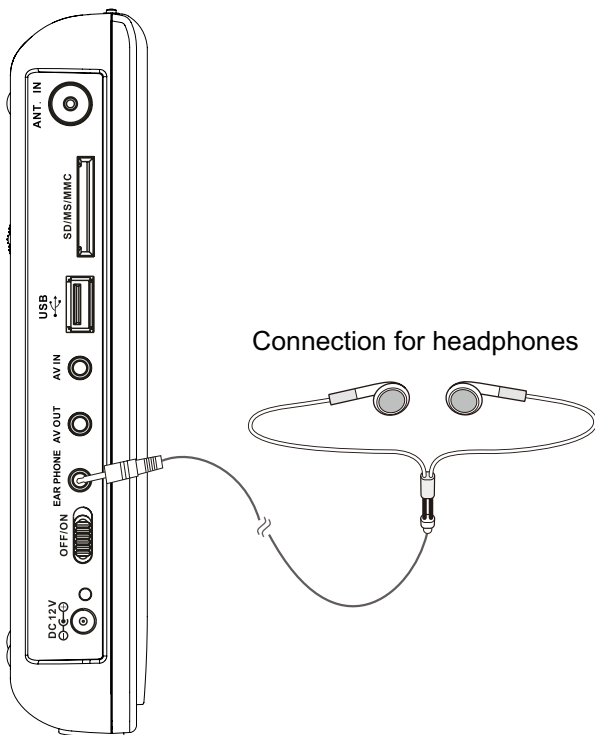

Powering the LCD TV

- To turn on the LCD TV.
Connect the DC power supply. Push the switch up, and then press **STANDBY** on the LCD TV.
- To turn off the LCD TV.
Press the **STANDBY** button on the LCD TV, and push the switch down.
- To turn on/off the LCD TV by remote control

Pressing  button.

Selecting Input Source

- * You can select between the TV signal and the input signal of other equipments connected to the TV.
- * Use this function to switch to the input source you wish to view.

Press  button on the remote control.

Use  to move to the desired input source.

Press  to select.



Operating the menu

1. Press **STANDBY** button to turn the LCD TV on.
2. Press **LCD-MENU** button on the remote control; the on-screen menu will appear on the screen.
3. Use **▲** and **▼** buttons to select your main menu option.
4. If you do not have a remote, use the following buttons to select an option from the sub-menu:
 LCD-Menu = menu or exit
 CH+/- = Scroll up and down
 Vol. + = Select

1. TV / DTV menu

Allows you to make adjustments to your picture settings.
 (Select TV/DTV source for example)

MENU	
BRIGHTNESS	50
CONTRAST	50
SATURATION	50
SHARPNESS	0
HUE	0

2. TV / DTV menu

Allows you to setup a variety of setup options.
 (Select TV/DTV source for example)

MENU	
LANGUAGE	ENGLISH
BLUE SCREEN	ON
WIDE SCREEN	16:9
RESET	→

3. TV menu

Allows you to search channels and setup a variety of channel options.
 (Select TV source for example)

MENU	
SKIP	ON
AFC	ON
FINETUNE	87.80MHZ
ANTENNA	AIR
AUTOSEARCH	→

3. DTV menu

Allows you to search channels and setup a variety of channel options.
 (Select DTV source for example)

MENU	
TIMEZONE	SAMOA
DAYLIGHT SAVE	OFF
ANTENNA	AIR
AUTOSEARCH	→

4. Use the **▲** and **▼** buttons to select an option of the sub-menu, and press the **▶** button.
 While in adjustment mode, use the **◀** and **▶** buttons to change the value of the item.
5. Press the **LCD-MENU** button to exit the menu.

Note:

Only when you input the suitable signal, the relevant items can be activated.

Customizing the PICTURE Settings

MENU	
BRIGHTNESS	50
CONTRAST	50
SATURATION	50
SHARPNESS	0
HUE	0

Press **LCD-MENU** button on the TV set to display the OSD MENU.

The OSD menu includes the following options:

Brightness	Controls the overall brightness of the picture
Contrast	Controls the difference between the brightest and darkest regions of the picture.
Saturation	Controls the saturation of the picture.
Sharpness	Increase this setting to see crisp edges in the picture; decrease it for soft edges.
Hue	Controls the hue(only used in NTSC mode).

Customizing the FUNCTION Settings

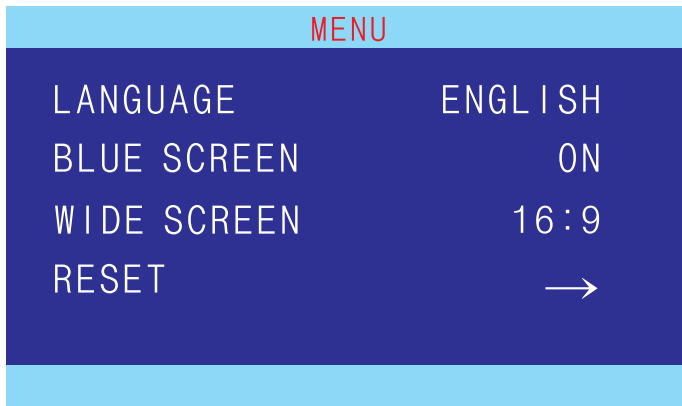

Press **LCD-MENU** button twice on the TV set to display the OSD MENU.

The FUNCTION menu includes the following options:

Language	Select the OSD menu language.
Blue Screen	Turn on/off the blue screen display when there's no signal.
Wide Screen	Control the OSD menu display mode on the screen: 16:9, 4:3.
Reset	Press ► button to reset all the set above.

Customizing the TUNING Settings

Tuning menu in TV mode

MENU	
SKIP	ON
AFC	ON
FINETUNE	87.80MHZ
ANTENNA	AIR
AUTOSEARCH	→

Tuning menu in DTV mode

MENU	
TIMEZONE	SAMOA
DAYLIGHT SAVE	OFF
ANTENNA	AIR
AUTOSEARCH	→

Press **LCD-MENU** button thrice on the TV set to display the OSD MENU.

The TUNING menu includes the following options:

Skip (in TV mode)	Skip the channel when you scan the channels with CH+/- button if you turn on the function.
AFC (in TV mode)	Automatic frequency control, the LCD TV will autosearch the best signal on the appointed frequency if you turn on the function.
Fine Tune (in TV mode)	Fine tune the frequency of the channel. Note: the AFC will be turned off automatically when you start to fine tune.
Time Zone	Select the Time Zone for your TV set according to you area.
Daylight Save	Turn on/off the Daylight Save function.
Antenna	Select the TV source input: AIR, CATV.
Autosearch	Press ▶ button, the screen will display a cue, and use ◀ and ▶ button to select "YES" or "NO", if you select "YES", and press ENTER button to confirm, it will start to autosearch.

EPG menu

Press **EPG** button on the remote control in DTV mode, the screen will display the Guide menu as below. Press **EPG** button to cancel.

Guide	
SAMPLE CHANNEL	
TIME	EVENT
05:00PM-05:30PM	Smart travels- Pacific Rim with Ruby
05:30PM-06:30PM	Nova
06:30PM-07:30PM	History Detectives
07:30PM-08:30PM	Buffalo's Houses
ABSTRACT	
This country is a narural-born beauty, winning us over with luxuriant landscapes and sleek scandinavian style. We cruise through Samiton's sun-dappled archipelago, visit a designer hotel and	
Page 1 of 5	

Note: The content shown in the picture above is just an example.

Closed Caption

Press **CC** button on the remote control in DTV mode, the screen will display the Closed Caption as below. Press **CC** button to cancel.

CC SETUP	
CC DISPLAY	ON
CC Type	Service 1
CC Mode	Broadcast
CC Customer	▶

CC Display Turn on/off the Closed Caption display.

CC Type Select the Closed Caption service.

CC Mode Select the Closed Caption mode from Broadcast/Customer.

CC Customer Press ▶ button to go to the CC customer menu to custom the CC style.
(Available only when the CC mode is selected to Customer)

CC Customer	
CC Size	Standard
CC Font	Font 0
CC Opacity	Solid
CC Color	White
Edge Color	Black
Edge Type	None
Bkgrd. Color	Black
Bkgrd. Opacity	Solid

Playing media files from the USB and SD card slots

- The following files formats **are supported** by this TV: JPG, MP3, WMA, MP4 (DivX3.11-5.11, Xvid), MPEG1 (DAT, MPG, MPEG), MPEG2 (mpeg, mpg).
- File formats including the following **are not supported** by this TV: BMP, PNG, AAC, DivX 6, DivX HD, Vob, ts.
- The following cards are supported by this TV: SD, MMC, Memory Stick (MS).
- Only full-size card formats are supported. If you wish to use compact formats such as miniSD, microSD, Memory Stick Duo etc., please be sure to use an adapter to convert to the full-size format.

1) Insert your USB device or card.

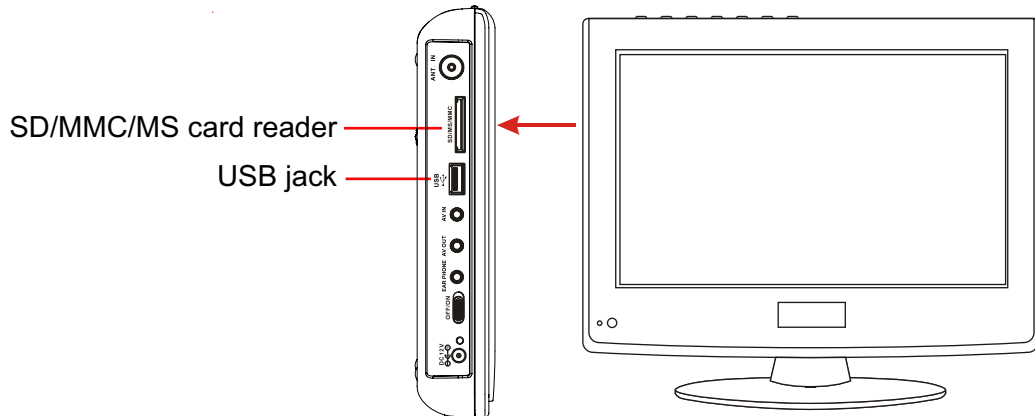

2) Press the **TV/AV** button to display the input source menu, Select "MEDIA" by ▲/▼ button, and press **ENTER** button to enter the device screen as below:



3) Play the Music, Video or view the Photos

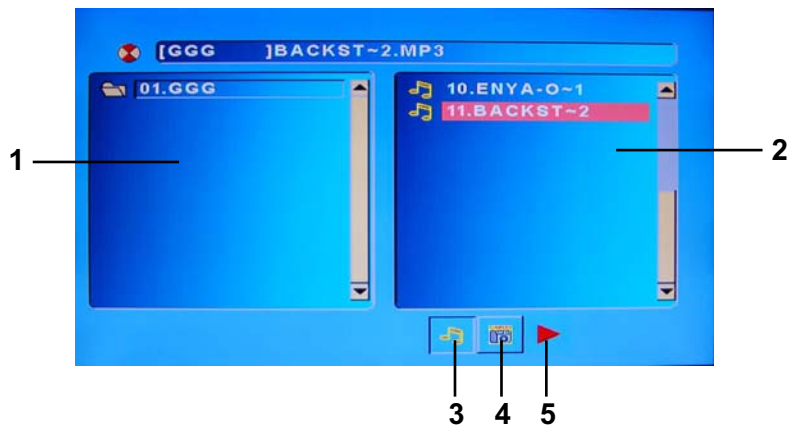

Playing media files from the USB and SD card slots

- ▶ Use ◀▶ to select **(3) - Music**, **(4) - Photo** or **(5) - Movie**. The list of folders is displayed in area **(1)**.
- ▶ Select area **(1)** using the ◀▶ keys and select the folder using ▲▼. The list of files is displayed in area **(2)**.
- ▶ Select area **(2)** using the ◀▶ keys and select the file you wish to play using ▲▼.
- ▶ Press **ENTER** button to begin playback.

NOTE:

1. Pressing the ■(**STOP**) button on the remote control during playback will halt playback and return to the file and folder navigation screen.
2. The following keys have specific functions during photo playback:
 - ◀▶ : Rotate image
 - ▲▼ : Flip image
 - ▶▶ : Display the next photo
 - ◀◀ : Display the previous photo

4) Buttons for MEDIA playing

DISPLAY : Press to display the current program information.

SLEEP : Timer.

ZOOM: Press to change the screen display mode.

VOL+/- : Volume up/down.

THUMBSTICK (▲/▼/◀/▶) : Allows you to navigate the on-screen menus and adjust the system settings to your preference.

ENTER : Confirm for source menu.

SUB : Press to turn on/off the subtitle display.

▶|| : Play/pause

■ : Stop

SLOW : Slow the playing speed.

SETUP : Press to display the system menu(see next page)

◀▶ : Fast reverse/forward.

◀◀ ▶▶ : Previous chapter/next chapter.

PROG : Edit the program and play.

A-B : Select and play the preferable paragraph of program by pressing this key twice at the beginning and end of it.

REPEAT : Repeat playing the title or chapter.

GOTO : Play your favorite title/chapter/track.



System Settings for Media

System operation will define the setting of the set; these definitions will be stored until you change them again.

General Steps of Setup Menu

1. Press **SETUP** on the remote control. The main menu will be shown as below.

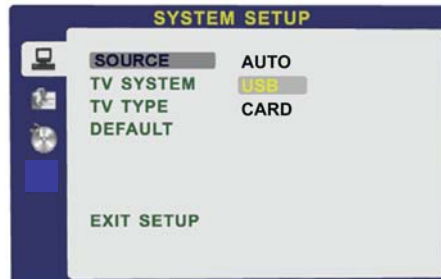

2. Press the ▲ / ▼ buttons to select the Icon of the desired section, e.g. "TV System" and press ► button to open that section.
 3. Press ▲ / ▼ to select the desired feature and again press ► button to open that section.
 4. Press ▲ / ▼ to select the desired feature and then press "**ENTER**" to select the new setting.
 - 5 To exit the menu, press "**SETUP**" or ▼ to select EXIT SETUP and then press "**ENTER**"
- When launching the setup routine, the pressing of the following buttons will turn off the setup menu, while the choices that have been changed will be saved.

Menu specification

1. SYSTEM SETUP

The system setup options are illustrated below:

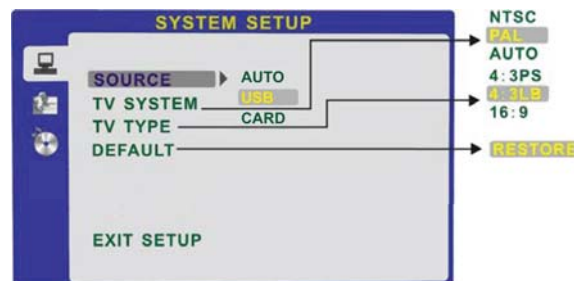

SOURCE

Select the source of the information you want to play: AUTO, CARD, USB

TV SYSTEM

According to the Color system of your TV, select proper TV TYPE.

TV TYPE

Format 4:3 PS, 4:3 LB, 16:9

System Settings for Media

2. LANGUAGE SETUP

The language setup options are illustrated below:

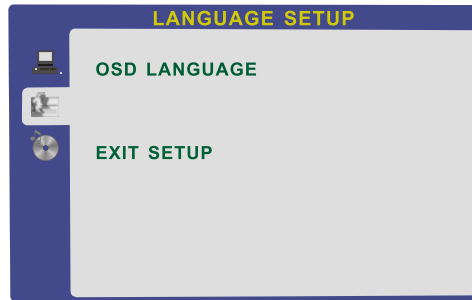

- OSD LANGUAGE: The OSD will display in the language you choose.

3. AUDIO SETUP

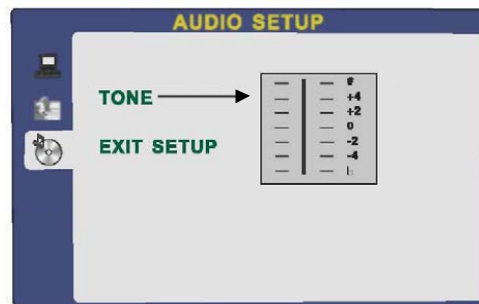

-TONE: Use the ▲ / ▼ button to move the scroll and adjust the tone.

Trouble shooting

- Do not use other functions that are not mentioned in this user's manual.
- In case a problem occurs with your LCD TV, please take the following steps first.
- If the problem still occurs, turn the power off and contact your dealer or an authorized service center.

Problem	Action
The screen does not appear.	Is the power plug pulled out? Insert the power plug. Press the power button.
The screen appears too slowly after the power is turned on.	This problem occurs for a brief time in the progression of image elimination processing in order to hide temporary screen noise that occurs when the power is turned on. If the screen does not appear after one minute, contact your dealer or an authorized service center.
Screen is too bright or too dark.	Perform brightness adjustment or contrast adjustment.
Screen is too large or too small.	Adjust the screen size.
Stripes appear on the screen and it shakes.	This problem can occur if wireless telephones, hair dryers, or electric drills are used near the TV.
Screen appears, Voice is not heard	<ol style="list-style-type: none"> 1. Press the "MUTE" button. 2. Increase the sound level by pressing volume adjustment button. 3. Check if sound terminal of external input is connected properly. 4. Check if audio cables are connected properly. 5. Select and check the other input. <p>If the sound still does not work and you have checked every channel to ensure that the problem is not channel specific, contact your dealer or an authorized service center.</p>
Remote control does not work	<ol style="list-style-type: none"> 1. Check if main power is On. 2. Check that the batteries of the remote controller were loaded properly. 3. Check to see if any obstacle exists between the LCD TV and the remote control. 4. If the batteries have no power, replace them with two new batteries.

- This LCD TV is for household use and registered as harmless on electromagnetic waves. You can use it in every location as well as residential areas.

VIÖRE™ LIMITED WARRANTY

Model: PLC10V49

This VIÖRE brand Product, as supplied and distributed by VIÖRE and delivered new in the original carton to the original purchaser is warranted by VIÖRE against manufacturing defects in materials and workmanship for a limited warranty period of one (1) year on parts and labor. However, there will be only a 90 day parts and labor limited warranty for commercial use.

Proof of purchase within one year from date of purchase in the form of a Bill of Sale, Receipt or Receipted Invoice is evidence the Product is within the limited warranty period. The Bill of Sale, Receipt or Receipted Invoice must be presented as a pre-condition to obtaining the limited warranty service.

This limited warranty begins on the original date of purchase, and is valid only on Products purchased through VIÖRE authorized dealers and used in the United States by the original purchaser. To receive warranty service, the purchaser must contact VIÖRE for problem determination and service procedures. Warranty service may only be performed by a duly authorized VIÖRE service center. The original dated bill of sale, receipt or receipted invoice must be presented upon request as proof of purchase to VIÖRE or VIÖRE's authorized service center.

VIÖRE will repair or if repairs cannot be made, VIÖRE will replace this Product at no charge if the Product is defective as specified in this limited warranty during the limited warranty period. VIÖRE may use new, or remanufactured parts or products to repair or replace the Product at its sole discretion. All replaced parts and Products become the property of VIÖRE and must be returned to VIÖRE. Replacement parts and Products assume the remaining original limited warranty, or ninety (90) days, whichever is longer.

Product freight needs to be prepaid by original purchaser and shipped in either its original packaging or packaging affording an equal degree of protection. VIÖRE shall not be responsible for or obligated to replace damaged goods. If you reside in California and you cannot transport the television due to the size, weight, and method of attachment, VIÖRE will provide transportation for the television to the repair facility. If you reside in a state other than California, you are responsible for the costs of transporting the television to a repair facility.

If the product is received damaged by VIÖRE, it is the responsibility of the consumer to file a claim against the carrier. VIÖRE will only store the damaged product for 30 days and reserves the right, in its sole discretion, to dispose of the damaged product or ship it back to the consumer at consumer's expense after 30 days.

This limited warranty covers manufacturing defects in materials and workmanship encountered in normal, and except to the extent otherwise expressly provided for in this statement, noncommercial use of this product, and shall not apply to the following, including, but not limited to: consumable parts, such as batteries, unless damage has occurred due to a defect in materials and workmanship; store display products; product sold as a "marked down" special; product sold in "as is" or, "open box" condition; products missing accessories; products received with no fault found; products damaged at time of delivery to VIÖRE; damage which occurs in shipment; delivery and installation; applications and uses for which this product was not intended; altered product or serial numbers; cosmetic damage or exterior finish; accidents, abuse, neglect, fire, water, lightning or other acts of nature; use of products, equipment, systems, utilities, services, parts, supplies, accessories, applications, installations, repairs, external wiring or connectors not supplied or authorized by VIÖRE which damage this product or result in service problems; incorrect electrical line voltage, fluctuations and surges; customer adjustments and failure to follow operating instructions, cleaning, maintenance and environmental instructions that are covered and prescribed in the instruction book; reception problems and distortion related to noise, echo, interference or other signal transmission and delivery problems; burned-in images. VIÖRE does not warrant uninterrupted or error-free operation of the product.

THERE ARE NO EXPRESS WARRANTIES OTHER THAN THOSE LISTED AND DESCRIBED ABOVE, AND NO WARRANTIES WHETHER EXPRESS OR IMPLIED, INCLUDING, BUT NOT LIMITED TO, ANY IMPLIED WARRANTIES OF MERCHANTABILITY OR FITNESS FOR A PARTICULAR PURPOSE, SHALL APPLY AFTER THE EXPRESS WARRANTY PERIODS STATED ABOVE, AND NO OTHER EXPRESS WARRANTY OR GUARANTY GIVEN BY ANY PERSON, FIRM OR CORPORATION WITH RESPECT TO THIS PRODUCT SHALL BE BINDING ON VIÖRE. REPAIR OR REPLACEMENT AS PROVIDED UNDER THIS LIMITED WARRANTY IS THE EXCLUSIVE REMEDY OF THE CONSUMER. VIÖRE SHALL NOT BE LIABLE FOR ANY INCIDENTAL, OR CONSEQUENTIAL DAMAGES FOR BREACH OF ANY EXPRESS OR IMPLIED WARRANTY ON THIS PRODUCT; EXCEPT TO THE EXTENT PROHIBITED BY APPLICABLE LAW, ANY IMPLIED WARRANTY OF MERCHANTABILITY OR FITNESS FOR A PARTICULAR PURPOSE ON THIS PRODUCT IS LIMITED IN DURATION TO THE DURATION OF THIS LIMITED WARRANTY. THIS LIMITED WARRANTY SHALL NOT EXTEND TO ANYONE OTHER THAN THE ORIGINAL PURCHASER OF THIS PRODUCT, IS NONTRANSFERABLE AND STATES YOUR EXCLUSIVE REMEDY.

Some states do not allow limitations on how long an implied warranty lasts, or the exclusion or limitation of incidental or consequential damages, so the above limitations or exclusions may not apply to you. This warranty gives you specific legal rights, and you may also have other rights which vary from state to state. Any provision contained herein which is found contrary to state or local laws shall be deemed null and void and the remaining provisions shall continue in full force and effect.

To obtain warranty service, please contact VIÖRE at:

Phone: 1-877-777-1428
www.viore.com

